



&
MEZZO

DIRECT VENT GAS FIREPLACE

HEAT & GLO



MODERN DESIGN
REDEFINED

MEZZO

You've never experienced modern design like this. Clean. Discreet. Luxurious. We spared nothing, to give you everything. It's modern design, redefined.

DETAILS MATTER

In clean modern design, it's all about the details. No gaps. Clean finishing. And quality. Every corner, every edge and every element of the MEZZO is all about perfection.

ELEVATE THE SENSES

Flames, lights, reflections and warmth combine to stimulate the senses. Flames spread across an illuminated bed of crushed glass. And a black glass interior adds depth and intensity to the fire. We dare you to take your eyes off of it.

DEFINE YOUR DESIGN

Your style, is yours. Express it by mixing and matching fronts, finishes and interior options to create a MEZZO uniquely yours.

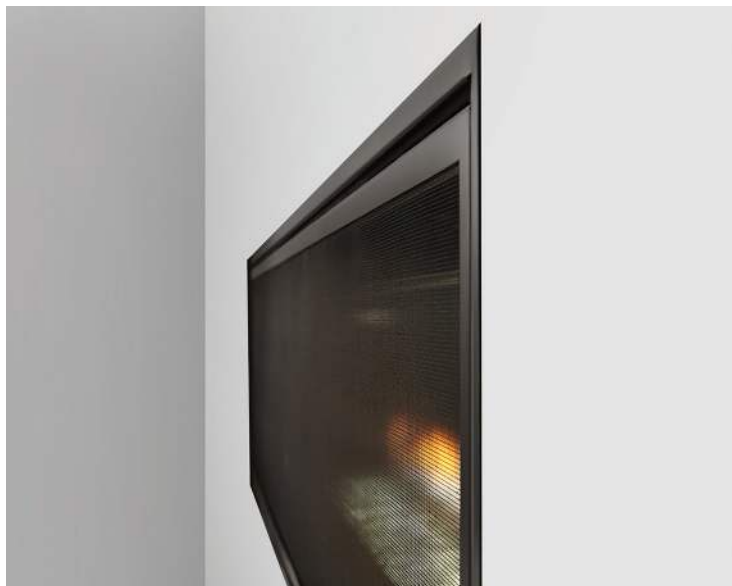

LEFT: MEZZO 72 See-Through shown with clean face trim in black and crystal glass media

COVER: MEZZO shown with iced fog glass media

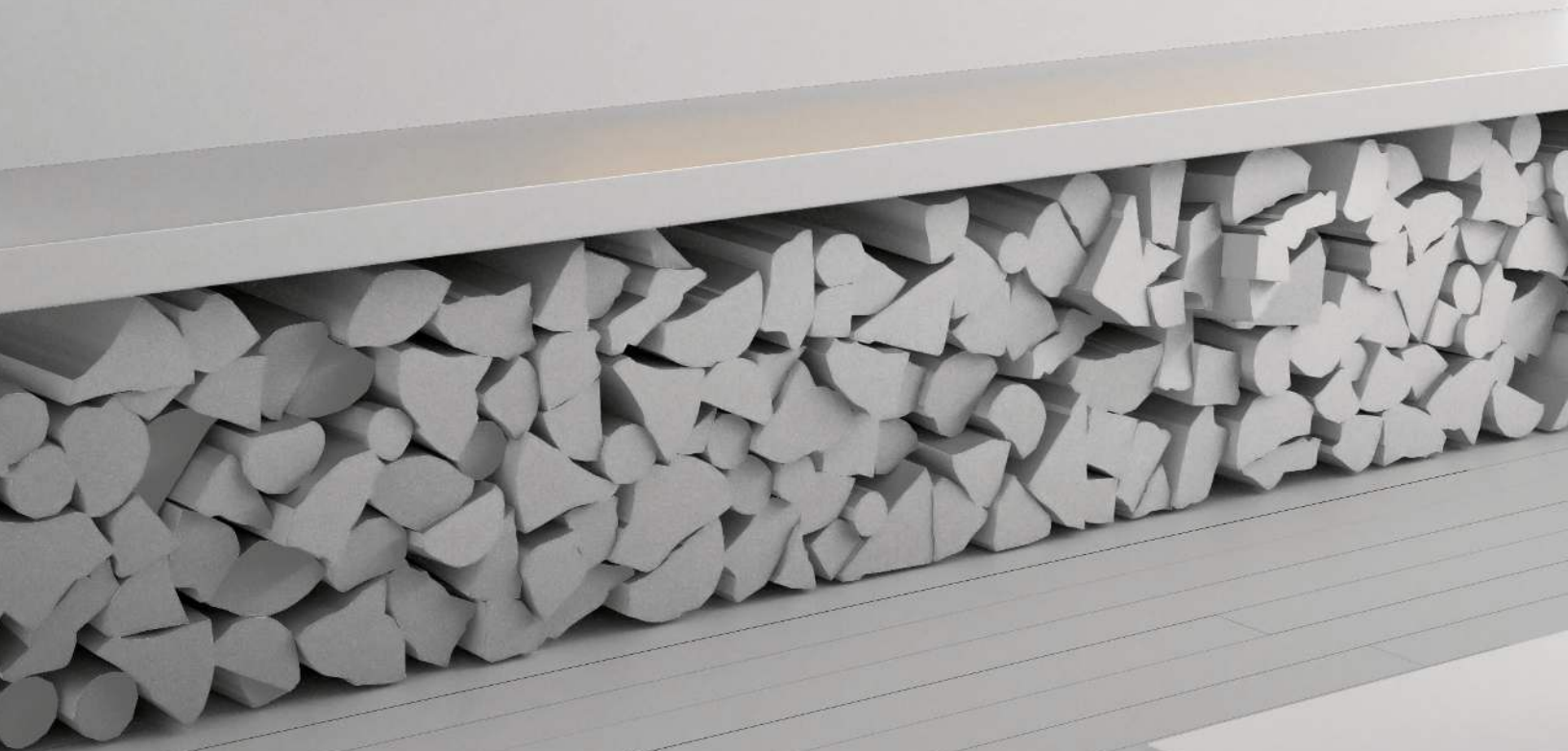

MEZZO 48 See-Through shown with loft forge front, iced fog glass media and natural logs

MODELS AVAILABLE

Choose a model to fit your space and application.

SINGLE-SIDED



SEE-THROUGH



FRONT OPTIONS

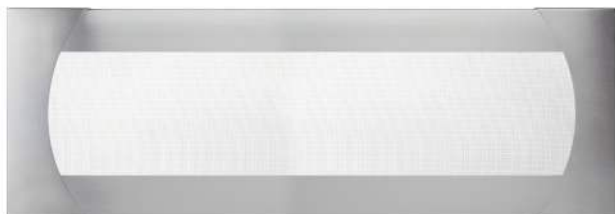

QUATTRO¹
An elegant four-piece design softly framing the view of the fire.



CLEAN FACE TRIM
A low-profile trim for a minimalist look. Also pairs well with custom wall treatments like stone or tile.



LOFT FORGE¹
Hand-forged metal with riveted accents for an industrial aesthetic. At home in a rustic cabin or modern loft.

FINISHES²



INTERIOR OPTIONS



CRYSTAL GLASS EBONY GLASS AMBER GLASS COBALT GLASS SCARLET GLASS ICED FOG GLASS NATURAL LOGS³

¹: Not available for 72-inch model ²: Loft Forge front available in hammered steel only. ³: Requires glass media



MEZZO 36 shown with quattro front in brushed nickel and cobalt glass media.



MEZZO 60 shown with clean face trim in black and amber glass media.

MEZZO TECHNOLOGIES



INTELLIFIRE PLUS IGNITION SYSTEM

An advanced intermittent pilot ignition system with memory settings and a programmable wireless RC300 remote control. IPI Plus constantly monitors ignition, ensures safe functioning and conserves up to \$10/month in energy costs.



DIRECT VENT TECHNOLOGY

Direct Vent fireplaces remove 100% of combustion exhaust and odors outside of the home. These sealed fireplaces provide optimal heat, conserve energy and ensure clean, safe indoor air quality.



CLEAR LED LIGHTING TECHNOLOGY

Superior performance and extended efficiency. This technology provides high-contrast, brilliant lighting to accentuate the flames. Can be used as mood lighting, with or without the flames.



FADE-RESISTANT BLACK GLASS INTERIOR

A clean modern look never gets dull. Just like this black glass interior. It's hot. And looks that way, too. For the life of your MEZZO.



HEAT ZONE TECHNOLOGY

Draw heat from the MEZZO into another room of the home, up to 20 feet away. When a heat zone kit is run continuously, it will redirect up to 25% of the fireplace's heat to another area, thus reducing wall temperatures above the fireplace. Two heat zones run continuously will redirect up to 50% of the fireplace's heat.



MEZZO SPECIFICATIONS

MODEL	FRONT WIDTH		BACK WIDTH		HEIGHT		DEPTH		GLASS SIZE	BTU/HOUR INPUT (NG)
	UNIT	FRAMING	UNIT	FRAMING	UNIT	FRAMING	UNIT	FRAMING		
MEZZO36, MEZZO36ST	46-3/16 [1173]	48-1/4 [1226]	46-3/16 [1173]	48-1/4 [1226]	41-3/4 [1060]	42 [1067]	17-1/8 [435]	18-1/4 [464] ST: 17 [432]	35-1/2 x 12-1/2 [908 x 318]	17,500 - 30,000
MEZZO48, MEZZO48ST	58 [1473]	60-1/4 [1530]	58 [1473]	60-1/4 [1530]	41-3/4 [1060]	42 [1067]	17-1/8 [435]	18-1/4 [464] ST: 17 [432]	47-1/2 x 12-1/2 [1207 x 318]	21,000 - 40,000
MEZZO60, MEZZO60ST	70 [1778]	72-1/4 [1835]	70 [1778]	72-1/4 [1835]	47-3/4 [1213]	48 [1219]	17-1/8 [435]	18-1/4 [464] ST: 17 [432]	59-1/2 x 12-1/2 [1511 x 318]	26,000 - 50,000
MEZZO72, MEZZO72ST	82 [2083]	84-1/4 [2140]	82 [2083]	84-1/4 [2140]	47-3/4 [1213]	48 [1219]	17-1/8 [435]	18-1/4 [464] ST: 17 [432]	71-1/2 x 12-1/2 [1861 x 318]	30,000 - 58,000

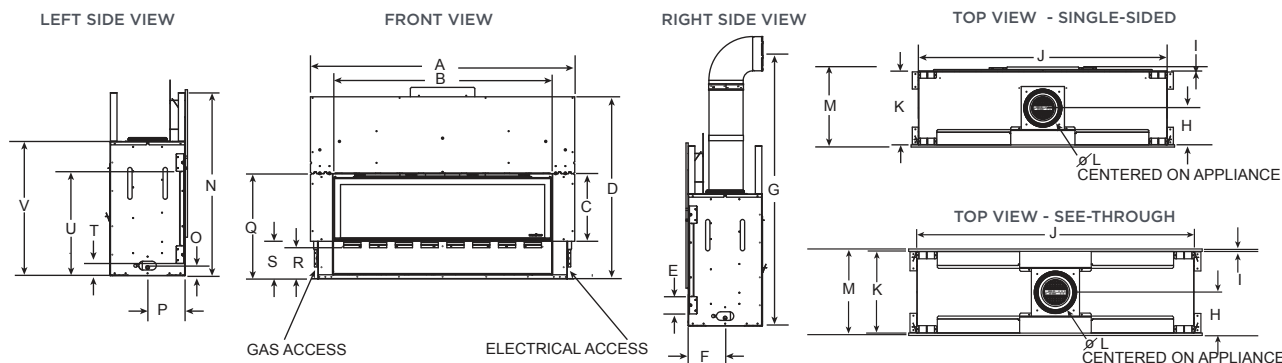

Model	A	B	C	D	E	F	G	H	I	J	K	L	M	N	O	P	Q	R	S	T	U	V
MEZZO36, MEZZO36ST	50 [1270]	39-1/4 [997]	15-5/8 [397]	42-1/2 [1080]	4 [102]	8-9/16 [217]	62 [1575]	8-9/16 [217]	1 [25] ST: 1/2 [13]	46-3/16 [1173]	17-1/8 [435]	8 [205]	18-5/8 [471] ST: 18-1/8 [460]	41-3/4 [1060]	2-3/8 [60]	8-9/16 [217]	24-1/2 [622]	7-1/4 [184]	8-7/8 [225]	2-3/4 [70]	23-3/4 [605]	30-1/2 [775]
MEZZO48, MEZZO48ST	62 [1575]	51-1/8 [1299]	15-5/8 [397]	42-1/2 [1080]	4 [102]	8-9/16 [217]	62 [1575]	8-9/16 [217]	1 [25] ST: 1/2 [13]	58 [1473]	17-1/8 [435]	8 [205]	18-5/8 [471] ST: 18-1/8 [460]	41-3/4 [1060]	2-3/8 [60]	8-9/16 [217]	24-1/2 [622]	7-1/4 [184]	8-7/8 [225]	2-3/4 [70]	23-3/4 [605]	30-1/2 [775]
MEZZO60, MEZZO60ST	74 [1880]	63-1/8 [1603]	15-5/8 [397]	48-1/2 [1232]	4 [102]	8-9/16 [217]	62 [1575]	8-9/16 [217]	1 [25] ST: 1/2 [13]	70 [1778]	17-1/8 [435]	8 [205]	18-5/8 [471] ST: 18-1/8 [460]	47-3/4 [1213]	2-3/8 [60]	8-9/16 [217]	24-1/2 [622]	7-1/4 [184]	8-7/8 [225]	2-3/4 [70]	23-3/4 [605]	30-1/2 [775]
MEZZO72, MEZZO72ST	86 [2184]	75-1/8 [1908]	15-5/8 [397]	48-1/2 [1232]	4 [102]	8-9/16 [217]	74 [1880]	8-9/16 [217]	1 [25] ST: 1/2 [13]	82 [2083]	17-1/8 [435]	8 [205]	18-5/8 [471] ST: 18-1/8 [460]	47-3/4 [1213]	2-3/8 [60]	8-9/16 [217]	24-1/2 [622]	7-1/4 [184]	8-7/8 [225]	2-3/4 [70]	23-3/4 [605]	30-1/2 [775]

Dimensions are in inches and millimeters. Product information is not complete and is subject to change without notice. Product installation must adhere strictly to instructions shipped with product. We recommend measuring individual units at installation. Assumes the use of 1/2" sheetrock. NOTE: Combustible material should not cover the face. Make sure you do NOT cover the decorative door opening.

Refer to installation manual for detailed specifications on installing this product. Heat & Glo® reserves the right to update units periodically. The flame and ember appearance may vary based on the type of fuel burned and the venting configuration used. Actual product appearance, including flame, may differ from product images.

U.S. EFFICIENCIES

Steady State - Since most homeowners use their fireplaces for an extended time while they are in the room, Steady State measures how efficiently your fireplace converts fuel to heat once it is warmed up and running in a “steady state”.

AFUE - AFUE rating is more typically used with appliances, like your furnace, that continually cycle on and off to maintain a constant temperature.

RATING	MEZZO36	MEZZO36ST	MEZZO48	MEZZO48ST	MEZZO60	MEZZO60ST	MEZZO72	MEZZO72ST
STEADY STATE	49.2% (NG), 49.2% (LP)	49.3% (NG), 49.3% (LP)	57.2% (NG), 57.2% (LP)	58.3% (NG), 58.3% (LP)	63.0% (NG), 64.1% (LP)	66.3% (NG), 67.7% (LP)	61.3% (NG), 63.1% (LP)	67.3% (NG), 69.3% (LP)
AFUE	44.1% (NG), 48.5% (LP)	39.7% (NG), 49.3% (LP)	46.4% (NG), 56.1% (LP)	48.3% (NG), 57.3% (LP)	58.0% (NG), 59.7% (LP)	61.1% (NG), 63.3% (LP)	56.6% (NG), 59.0% (LP)	62.4% (NG), 65.1% (LP)

CANADA EFFICIENCIES

EnerGuide (CSA P.4.1-02) - EnerGuide is a rating used in Canada to measure annual fireplace efficiency.



RATING	MEZZO36	MEZZO36ST	MEZZO48	MEZZO48ST	MEZZO60	MEZZO60ST	MEZZO72	MEZZO72ST
ENERGUIDE (CSA P.4.1-02)	47.8% (NG), 50.8% (LP)	45.9% (NG), 50.1% (LP)	53.2% (NG), 56.3% (LP)	51.3% (NG), 57.0% (LP)	52.6% (NG), 52.2% (LP)	57.4% (NG), 56.1% (LP)	51.3% (NG), 49.9% (LP)	55.9% (NG), 57.7% (LP)

For complete information on this model,
please contact us at:

HEAT & GLO®

No one builds a better fire

Web: heatnglo.com
Phone: (888) 427-3973 (952) 985-6000
E-mail: info@heatnglo.com

 facebook.com/HeatandGlo
 twitter.com/HeatandGlo
 youtube.com/HeatandGlo

HNG-1134U-0315

LIMITED LIFETIME WARRANTY*

The strongest in the industry, Heat & Glo® provides a limited lifetime warranty on the most important aspects: firebox and heat exchanger.

*For full warranty details, go to www.heatnglo.com.
Fireplace glass and other surfaces get extremely HOT and can cause severe burns if touched. Do not remove the protective safety screen from the front of the glass. Keep a safe distance away. To learn more visit www.heatnglo.com/fireplacesafety

