

# INSERTS

DIRECT VENT GAS FIREPLACE INSERTS

HEAT & GLO®



Available IntelliFire®  
app and voice control





# GAS INSERTS

**INSPIRED INNOVATION.** You don't have to sacrifice the warmth and glow of a wood burning fireplace for the simplicity and ease of gas. No more drafty, dated fireplace with messy maintenance, soot and smoke. Heat & Glo gas inserts fit inside an existing masonry or manufactured wood burning fireplace, providing an instant upgrade. Warm up to greater performance, safety and convenience.

FIRE MADE  
EASY

ESCAPE-30 FireBrick® shown with Chateau Forge front



---

# AN INSTANT UPGRADE

---



NO MESS. NO HASSLE.

# ESCAPE

## STANDARD FEATURES

- 30" and 35" viewing areas
- Up to 40,000 BTUs
- IntelliFire Touch® ignition system with touchscreen remote control
- Six hand-painted oak-style logs
- Anti-reflective glass
- ClearVue™ screen
- Patented FireBrick® seamless interior
- Five front designs
- Three surround sizes
- Illuminated ember bed
- Fan

## OPTIONAL FEATURE

- IntelliFire® app and voice control

BEST



BETTER



GOOD



# SUPREME

## STANDARD FEATURES

- 25", 30" and 35" viewing areas
- Up to 35,000 BTUs
- IntelliFire Touch ignition system with touchscreen remote control
- Ceramic glass with basic screen
- Oak-style or Natural Birch logs (30" only):
  - Five logs for 25" and 30" inserts
  - Six logs for 35" insert
- Three front designs\*
- Three surround sizes
- Fan

## OPTIONAL FEATURES

- IntelliFire app and voice control
- Interior panels
- Accent Lighting (30" and 35" only)

# PROVIDENT

## STANDARD FEATURES

- 30" and 35" viewing areas
- Up to 32,700 BTUs
- IntelliFire ignition system
- Ceramic glass with basic screen
- Four ceramic fiber logs
- One front design\*
- Three surround sizes

## OPTIONAL FEATURES:

- Interior panels
- Remote
- Fan

\*Inside fit front available for use with custom surrounds that are smaller than a standard overlap door



# COSMO

## STANDARD FEATURES

- 30" and 35" viewing areas
- Up to 30,000 BTUs
- IntelliFire Touch ignition system with touchscreen remote control
- Three front designs\*
- Three surround sizes
- Fade resistant fluted black glass
- Six glass media options (required for install)
- Fan

## OPTIONAL FEATURE

- IntelliFire app and voice control

\*Inside fit front available for use with custom surrounds that are smaller than a standard overlap door



## THREE EASY STEPS TO UPGRADE YOUR EXISTING WOOD-BURNING FIREPLACE:

### STEP 1: MEASURE YOUR EXISTING FIREPLACE AND SELECT YOUR INSERT.

The height, width and depth of the existing fireplace opening is needed to ensure selection of an appropriately-sized insert:

- A. Fireplace front width \_\_\_\_\_ E. Hearth to mantel height \_\_\_\_\_
- B. Fireplace back width \_\_\_\_\_
- C. Fireplace front height \_\_\_\_\_
- D. Fireplace depth \_\_\_\_\_
- If you have a manufactured wood burning fireplace, measure from the inside of the fireplace opening, not the outside trim.

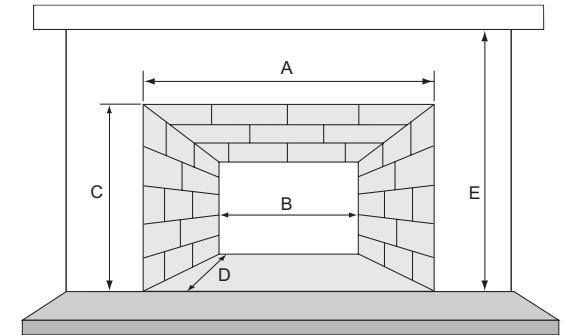

### STEP 2: SELECT YOUR FRONT AND SURROUND

Personalize your gas insert with a front and finish that fits your style. Include a surround to fill the gap between the gas insert and existing fireplace opening. Choose from three sizes and three finishes for a unique look.

SURROUND	ESCAPE-35-IFT SUPREME-135-IFT COSMO-135-IFT	ESCAPE-30-IFT SUPREME-130-IFT SUPREME-130-BIR COSMO-130-IFT	SUPREME-125-IFT
Small	42" x 29"	40" x 27"	35" x 23"
Medium	44" x 32"	42" x 30"	37" x 26"
Large	48" x 32"	44" x 32"	39" x 28"

- SMALL SURROUND
- MEDIUM SURROUND
- LARGE SURROUND

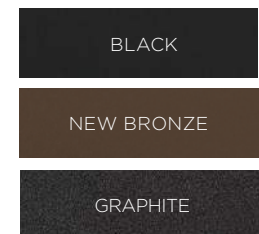
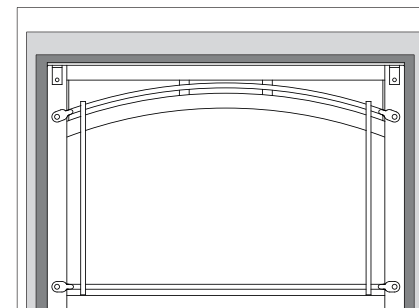

### STEP 3: SELECT YOUR OPTIONS

Choose from our collection of fronts, interior panels, interior media to put the finishing touches on your insert.

# FRONT OPTIONS

## BEST ESCAPE

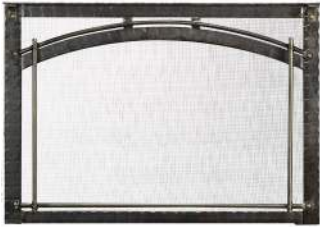

**CHATEAU FORGE** Available in hand-crafted, hammered steel.



**GALLERIA** Available in black, new bronze or graphite.

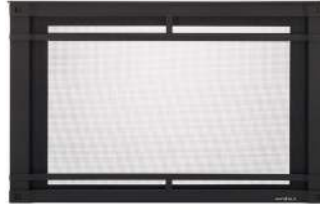

**HALSTON** Available in black, new bronze or graphite.



**IRON AGE** Available in black, new bronze or graphite.



**FIRESCREEN** Available in black, new bronze or graphite.

## BETTER SUPREME



**HALSTON ARCH** Available black, new bronze or graphite.



**IRON AGE** Available in black, new bronze or graphite.



**FIRESCREEN** Available in black, new bronze or graphite.

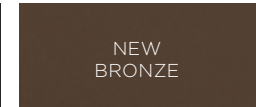
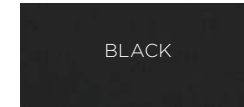

## GOOD PROVIDENT



**FIRESCREEN** Available in black, new bronze or graphite.

## TRANSITIONAL OR MODERN COSMO



**HALSTON ARCH** Available black, new bronze or graphite.



**IRON AGE** Available in black, new bronze or graphite.



**FIRESCREEN** Available in black, new bronze or graphite.

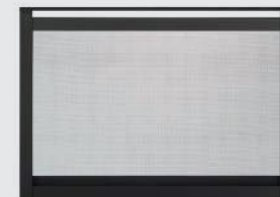

**INSIDE FIT** Available in black for Supreme, Provident and COSMO for installations that require a front smaller than a standard overlap door.

# INTERIORS

## ESCAPE



FIREBRICK SEAMLESS INTERIOR (Standard)

## SUPREME AND PROVIDENT

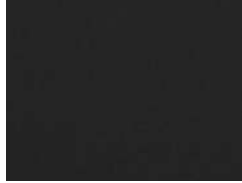

BLACK METAL (Standard)



STRATFORD TEXTURED BRICK (Optional upgrade on Supreme and Provident)



TRANQUIL GREIGE HERRINGBONE BRICK (Optional upgrade on Supreme)



REFLECTIVE BLACK GLASS (Optional upgrade on Supreme)

## COSMO



FLUTED BLACK GLASS (Standard)



REFLECTIVE BLACK GLASS (Optional)

## SUPREME 30" LOG OPTION



NATURAL BIRCH LOGS

## COSMO INTERIOR OPTIONS

Customize your fire. Each distinctive option highlights the flames differently. Glass media required for installation.



CLEAR GLASS



EBONY GLASS



AMBER GLASS



COBALT GLASS



SCARLET GLASS



ICED FOG GLASS



CERAMIC RIVER ROCK STONES (Optional)



DRIFTWOOD LOGS (Optional)

# CONTROLS

## INTELLIFIRE APP

All the features of a remote control with an app installed on your smart device. Monitor your fire from anywhere or even control it with the sound of your voice. IntelliFire is compatible with voice assistants Amazon Alexa and Google Assistant.



## TOUCHSCREEN REMOTE

Features: on/off, flame height adjustment, fan speed, lights adjustment, thermostat mode, room temperature readout, child lock, timer mode, battery backup, cold climate mode, power vent, wall docking station (fan, lights and power vent are dependent on your fireplace).



## WIRELESS WALL SWITCH

Features: on/off, battery strength indicator, cold climate mode



## PROVIDENT: SMARTREMOTE

Features: on/off, timer mode, thermostat mode, room temperature readout



# TERMINATION CAPS

A termination cap finishes your gas insert with a clean, upscale look. These durable caps also protect venting components and ensure safe exhaust flow.



ROUND CAP



SQUARE CAP Available in black or copper finish





SUPREME-30 shown with Iron Age front in graphite, reflective black glass interior panels and Natural Birch logs





COSMO-35 metal insert shown with Halston Arch front in bronze, fluted glass interior and glass media



ESCAPE-30 FireBrick insert shown with Galleria front in bronze



SUPREME-25 metal insert shown with Iron Age front in black and Tranquil Greige herringbone interior



Provident-30 metal insert shown with Firescreen front in black and metal interior



## TECHNOLOGIES



### INTELLIFIRE TOUCH IGNITION SYSTEM

IntelliFire Touch is our most advanced intermittent-pilot ignition (IPI) system, making operating your appliance simple, smart and safe. Select the IntelliFire app, touch-screen remote control or wireless wall switch for the solution that fits your lifestyle.



### INTELLIFIRE IGNITION SYSTEM (IPI)

IntelliFire features intermittent-pilot ignition (IPI) allowing you to conserve fuel and money when the fireplace is not in use.



### DIRECT VENT TECHNOLOGY

Direct Vent gas inserts remove 100% of combustion exhaust and fumes to the outside of the home. These sealed fireplaces provide optimal heat, conserve energy and ensure clean, safe indoor air quality.



### FIREBRICK TECHNOLOGY

Available on Escape inserts, FireBrick is a patented, energy-saving ceramic material molded in an authentic masonry design. FireBrick produces up to 25% more radiant heat than metal fireboxes—heating rooms faster and using less fuel. This increases efficiency and reduces heating costs. A unique ceramic composition is at the core of the FireBrick innovation.



## STANDARD FEATURE COMPARISON

PACKAGE	MODEL	IGNITION SYSTEM	FRONT DESIGN OPTIONS	VIEWING AREA	FAN	REMOTE CONTROL	INTELLIFIRE APP/VOICE CONTROL	THERMOSTAT CONTROL	INTERIOR PANELS	ACCENT LIGHTING
<b>BEST</b>	ESCAPE 30"/35"	IntelliFire Touch	5	Anti-reflective glass with ClearVue screen	Yes	Touchscreen Remote	Optional	Yes	Patented FireBrick	Yes
<b>BETTER</b>	SUPREME 25"/30"/35"	IntelliFire Touch	3*	Ceramic glass with basic screen	Yes	Touchscreen Remote	Optional	Yes		
<b>GOOD</b>	PROVIDENT 30"/35"	IntelliFire (IPI)	1*	Ceramic glass with basic screen						
<b>TRANSITIONAL OR MODERN</b>	COSMO 30"/35"	IntelliFire Touch	3*	Ceramic glass with basic screen	Yes	Touchscreen Remote	Optional	Yes	Fluted Reflective Black Glass	

\*Inside fit front is available for installations that require a custom surround that is smaller than a standard overlap door.

## EFFICIENCIES

### EnerGuide (CSA P.4.1-15)

Used in Canada and some US states to measure annual fireplace efficiency.

MODEL	RATING
ESCAPE-35-IFT	72.90% (NG), 73.80% (LP)
ESCAPE-30-IFT	70.70% (NG), 71.10% (LP)

MODEL	RATING
SUPREME-I35	71.61% (NG), 71.20% (LP)
SUPREME-I30	70.91% (NG), 71.00% (LP)
SUPREME-I30-BIR	70.91% (NG), 71.00% (LP)
SUPREME-I25	68.01% (NG), 66.00% (LP)

MODEL	RATING
PROVIDENT-I35	74.80% (NG), 74.40% (LP)
PROVIDENT-I30	67.70% (NG), 70.10% (LP)

MODEL	RATING
COSMO-I35	72.01% (NG), 69.20% (LP)
COSMO-I30	69.81% (NG), 69.00% (LP)



# ESCAPE SPECIFICATIONS

MODEL	FRONT WIDTH (A)		BACK WIDTH (B)		HEIGHT (C)		DEPTH (D)		GLASS SIZE (E X F)	BTU/HOUR INPUT (NG)	CONVECTION BLOWER
	UNIT	MIN. FIREBOX OPENING	UNIT	MIN. FIREBOX OPENING	UNIT	MIN. FIREBOX OPENING	UNIT	MIN. FIREBOX OPENING			
ESCAPE-35-IFT	34-5/8 [879]	35-1/8 [892]	25 [635]	25-1/2 [648]	24-3/8 [619]	24-5/8 [625]	17-7/8 [454]	18-1/8 [460]	31-3/8 x 19-7/8 [797 x 505]	40,000	120 CFM
ESCAPE-30-IFT	30 [762]	30-1/2 [775]	21 [533]	21-1/2 [546]	22-3/8 [568]	22-5/8 [575]	16-3/8 [410]	16-5/8 [422]	26-11/16 x 17-7/8 [678 x 454]	36,000	120 CFM

LEFT SIDE VIEW

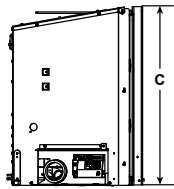

FRONT VIEW



TOP VIEW

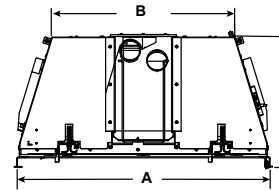

RIGHT SIDE VIEW

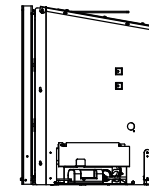

# SUPREME, COSMO & PROVIDENT SPECIFICATIONS

MODEL	FRONT WIDTH [A]		BACK WIDTH [B]		HEIGHT [C]		DEPTH [D]		GLASS SIZE [E X F]	BTU/HOUR INPUT (NG)	CONVECTION BLOWER
	UNIT	MIN. FIREBOX OPENING	UNIT	MIN. OPEN	UNIT	MIN. FIREBOX OPENING	UNIT	MIN. FIREBOX OPENING			
SUPREME-I25-IFT	26-1/8" [664mm]	26-5/8" [676mm]	14-5/8" [372mm]	15-1/8" [384mm]	17-1/16" [433mm]	17-5/16" [439mm]	14-1/2" [368mm]	15" [381mm]	22-1/2" X 12-7/16" [572mm X 316mm]	27,000	160 CFM
SUPREME-I30-IFT	31-1/8" [791mm]	31-5/8" [803mm]	19-5/8" [499mm]	20-1/8" [511mm]	20-3/4" [527mm]	21" [533mm]	14-1/2" [368mm]	15" [381mm]	27-1/2" X 15-15/16" [699mm X 405mm]	32,700	160 CFM
SUPREME-I30-BIR	31-1/8" [791mm]	31-5/8" [803mm]	19-5/8" [499mm]	20-1/8" [511mm]	20-3/4" [527mm]	21" [533mm]	14-1/2" [368mm]	15" [381mm]	27-1/2" X 15-15/16" [699mm X 405mm]	32,700	160 CFM
SUPREME-I35-IFT	36-1/8" [918mm]	36-5/8" [930mm]	24-5/8" [626mm]	25-1/8" [638mm]	24" [610mm]	24-1/4" [616mm]	14-1/2" [368mm]	15" [381mm]	32-1/2" X 19-3/8" [826mm X 492mm]	35,000	160 CFM
PROV-I30-IPI	31-1/8" [791mm]	31-5/8" [803mm]	19-5/8" [499mm]	20-1/8" [511mm]	20-3/4" [527mm]	21" [533mm]	14-1/2" [368mm]	15" [381mm]	27-1/2" X 15-15/16" [699mm X 405mm]	30,000	160 CFM
PROV-I35-IPI	36-1/8" [918mm]	36-5/8" [930mm]	24-5/8" [626mm]	25-1/8" [638mm]	24" [610mm]	24-1/4" [616mm]	14-1/2" [368mm]	15" [381mm]	32-1/2" X 19-3/8" [826mm X 492mm]	32,700	160 CFM
COSMO-I30-IFT	31-1/8" [791mm]	31-5/8" [803mm]	19-5/8" [499mm]	20-1/8" [511mm]	20-3/4" [527mm]	21" [533mm]	14-1/2" [368mm]	15" [381mm]	27-1/2" X 15-15/16" [699mm X 405mm]	28,000	160 CFM
COSMO-I35-IFT	36-1/8" [918mm]	36-5/8" [930mm]	24-5/8" [626mm]	25-1/8" [638mm]	24" [610mm]	24-1/4" [616mm]	14-1/2" [368mm]	15" [381mm]	32-1/2" X 19-3/8" [826mm X 492mm]	30,000	160 CFM

LEFT SIDE VIEW

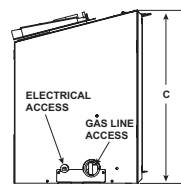

FRONT VIEW

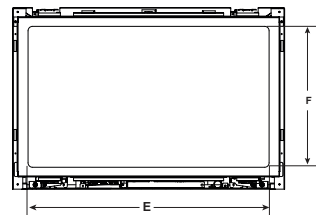

TOP VIEW

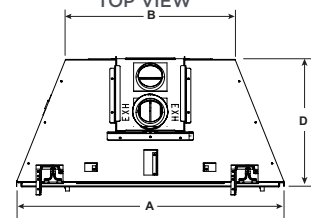

RIGHT SIDE VIEW

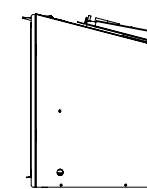

Dimensions above are in inches. Reference dimensions only. We recommend measuring individual units at installation. NOTE: Combustible material should not be installed over the face. Make sure you do NOT cover the decorative door opening. Refer to installation manual for detailed specifications on installing this product. Heat & Glo reserves the right to update units periodically. The flame and ember appearance may vary based on the type of fuel burned and the venting configuration used. Pictures in this brochure are not a true representation of the fireplace and/or flames.





For complete information on these models, please contact us at:

**HEAT & GLO**

No one builds a better fire

Web: [heatnglo.com](http://heatnglo.com)  
Phone: (888) 427-3973  
E-mail: [info@heatnglo.com](mailto:info@heatnglo.com)

 [facebook.com/HeatandGlo](https://facebook.com/HeatandGlo)  
 [twitter.com/HeatandGlo](https://twitter.com/HeatandGlo)  
 [youtube.com/HeatandGlo](https://youtube.com/HeatandGlo)

HNG-1142U-0922

#### LIMITED LIFETIME WARRANTY<sup>2</sup>

The strongest in the industry, Heat & Glo® provides a limited lifetime warranty on the most important aspects: firebox and heat exchanger.

<sup>2</sup>For full warranty details, go to [www.heatnglo.com](http://www.heatnglo.com).

Fireplace glass and other surfaces get extremely HOT and can cause severe burns if touched. Do not remove the protective safety screen from the front of the glass. Keep a safe distance away. To learn more visit [www.heatnglo.com/fireplacesafety](http://www.heatnglo.com/fireplacesafety)

Google, YouTube and Google Home are trademarks of Google LLC. Amazon, Alexa, and all related logos are trademarks of Amazon.com, Inc. or its affiliates.

