

# PREMIER

WOOD-BURNING FIREPLACES

HEAT & GLO



TRADITION  
YOU CAN FEEL





# WOOD FIREPLACES

Keep the home fires burning with an authentic indoor wood fireplace that costs much less than a site-built masonry fireplace. Wood burners appreciate the radiant heat and efficiency that delivers the most from every cord.

## RUTHERFORD A

Bold performance and a custom-built masonry appearance. With the biggest viewing area in its class—available in three sizes, up to 50" wide—in a tall firebox, the Rutherford indoor wood fireplace commands attention. And, it costs far less than custom-built masonry fireplace.

## NORTHSTAR B

The super-efficient Northstar exceeds EPA-certified standards as perhaps the cleanest wood-burning fireplace on the planet—ideal where conventional wood fireplaces are banned. Warm up to 10 hours from each wood load.



COVER: RUTHERFORD

LEFT: RUTHERFORD 50 shown with Natural Gray herringbone interior panels and mesh screen

### EXCLAIM C

Enjoy a beautiful wood-burning fireplace with our attractively priced Exclaim. Bring the ambiance of a crackling fire into your home with spacious viewing up to 50" and a choice of brick interiors. Choose square or contoured doors to complete your look. Available in three sizes.



### ROYAL HEARTH D

It's easier to relax with the Royal Hearth in the room. An easy-to-operate damper, helpful ash lip and invisible smoke shield add convenience to tradition. Available in two sizes.



DOOR OPTIONS

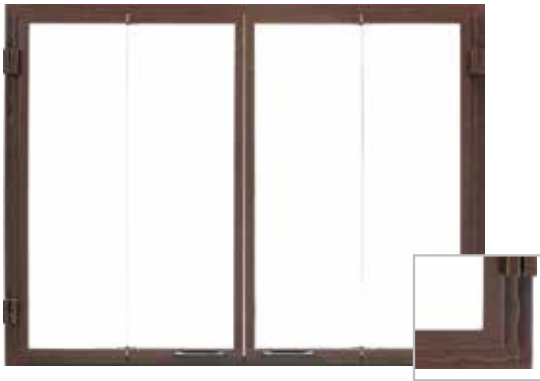

BI-FOLD GLASS DOORS Available in black or bronze for Rutherford models only.



GRAND VISTA MESH DOORS Available in black or bronze for Exclaim model only.

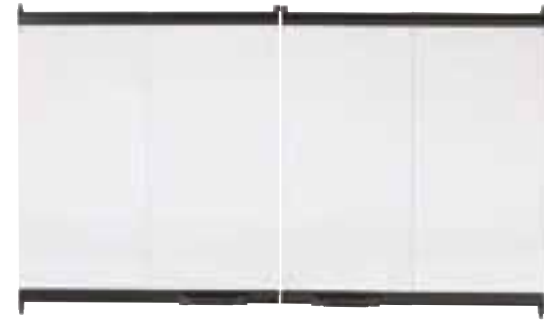

BI-FOLD GLASS DOORS Available in black or stainless steel trim. Not available for Rutherford models.

DOOR FINISHES



INTERIOR OPTIONS Rutherford and Exclaim models come with your choice of traditional or herringbone refractories.

RUTHERFORD FIREBRICK YELLOW



TRADITIONAL



HERRINGBONE

EXCLAIM



TRADITIONAL

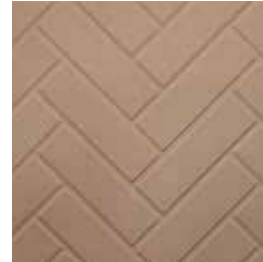

HERRINGBONE

RUTHERFORD NATURAL GRAY



TRADITIONAL



HERRINGBONE

RUTHERFORD ANDIRONS Standard cast iron andirons help you build bigger, bolder fires and add style to your firebox.



# SPECIFICATIONS

## RUTHERFORD SPECIFICATIONS

MODEL	FRONT WIDTH		BACK WIDTH		HEIGHT		DEPTH		FIREBOX OPENING
	UNIT	FRAMING	UNIT	FRAMING <sup>1</sup>	UNIT	FRAMING	UNIT	FRAMING	
RUTHERFORD-36	46-7/8 [1191]	47-7/8 [1216]	31-1/8 [790]	47-7/8 [1216]	74-1/8 [1883]	74-1/4 [1886]	27-1/2 [699]	28-1/2 [724]	36 x 38 [914 x 965]
RUTHERFORD-42	52-7/8 [1343]	53-7/8 [1368]	37-1/8 [943]	53-7/8 [1368]	74-1/8 [1883]	74-1/2 [1892]	27-1/2 [699]	28-1/2 [724]	42 x 38 [1067 x 965]
RUTHERFORD-50	60-7/8 [1546]	61-7/8 [1572]	45-1/8 [1146]	61-7/8 [1572]	74-1/8 [1883]	74-1/2 [1892]	27-1/2 [699]	28-1/2 [724]	50 x 38 [1270 x 965]

Drawings below represent the Rutherford 36, 42, & 50 combined.

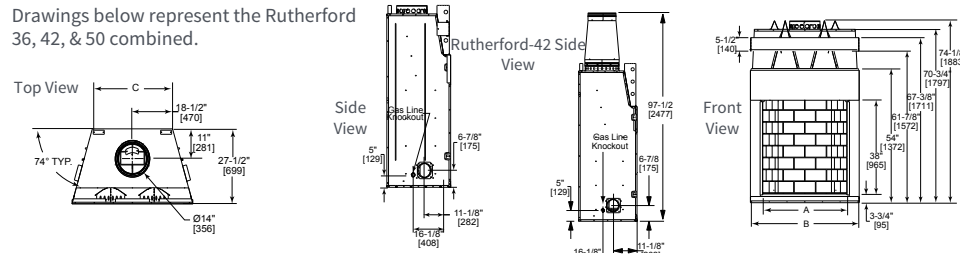

MODEL	A	B	C
RUTHERFORD-36	36 [914]	46-7/8 [1191]	31-1/8 [790]
RUTHERFORD-42	42 [1067]	52-7/8 [1343]	37-1/8 [943]
RUTHERFORD-50	50 [1270]	60-7/8 [1546]	45-1/8 [1146]

## NORTHSTAR SPECIFICATIONS

MODEL	FRONT WIDTH		BACK WIDTH		FRONT HEIGHT		REAR HEIGHT		DEPTH		FIREBOX OPENING
	Unit	Framing	Unit	Framing <sup>1</sup>	Unit	Framing	Unit	Framing	Unit	Framing	
Northstar-C*	40 [1016]	42-1/2 [1080]	40 [1016]	42-1/2 [1080]	40-1/2 [1029]	56-3/4 [1441]	40-1/2 [1029]	56-3/4 [1442]	23-1/2 [597]	24** [610]**	37 x 31-1/8 [940 x 791]

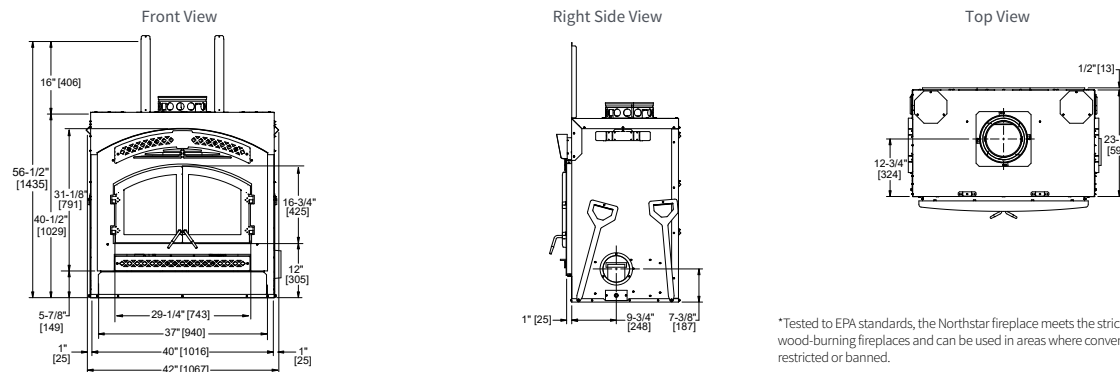

\*Tested to EPA standards, the Northstar fireplace meets the strictest environmental standards for wood-burning fireplaces and can be used in areas where conventional wood-burning appliances are restricted or banned.

\*\*If interior of chase will be drywalled, add the thickness to this measurement.

Dimensions for all fireplaces are in inches and millimeters. Reference dimensions only. We recommend measuring individual units at installation. Assumes the use of 1/2" [13] Sheetrock. NOTE: Non-combustible material is allowed over this dimension. Make sure you do NOT cover the decorative door opening.

Refer to installation manual for detailed specifications on installing this product. Heat & Glo reserves the right to update units periodically. Actual product appearance, including flame, may differ from product images.

<sup>1</sup> When using outside air, refer to install manual for framing dimensions.

**EXCLAIM SPECIFICATIONS**

MODEL	FRONT WIDTH		BACK WIDTH		FRONT HEIGHT		REAR HEIGHT		DEPTH		FIREBOX OPENING
	UNIT	FRAMING	UNIT	FRAMING <sup>1</sup>	UNIT	FRAMING ROUGH OPENING	UNIT	FRAMING	UNIT	FRAMING	
EXCLAIM-36	44-1/2 [1130]	45-1/2 [1156]	28-5/8 [727]	45-1/2 [1156]	49-5/8 [1260]	59-3/4 [1518]	59-1/4 [1505]	59-3/4 [1518]	27-1/2 [699]	28 [711]	36 x 28-1/2 [914 x 724]
EXCLAIM-42	50-1/2 [1283]	51-1/2 [1308]	34-1/2 [876]	51-1/2 [1308]	49-5/8 [1260]	59-3/4 [1518]	59-1/4 [1505]	59-3/4 [1518]	27-1/2 [699]	28-1/2 [724]	42 x 28-1/2 [1067 x 724]
EXCLAIM-50	60-5/8 [1540]	61-5/8 [1565]	41-5/8 [1057]	61-5/8 [1565]	60-1/4 [1530]	71 [1803]	70-1/2 [1791]	71 [1803]	29-1/2 [749]	30-1/2 [772]	50 x 33 [1270 x 838]

Drawings below represent the Exclaim 36, 42, & 50 combined.

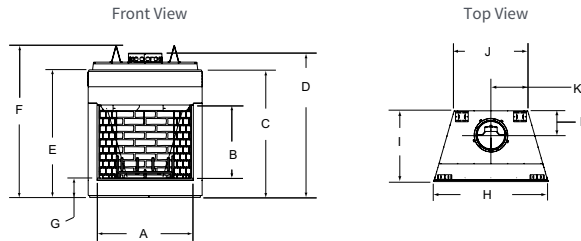

MODEL	A	B	C	D	E	F	G	H	I	J	K	L
EXCLAIM 36	36 [914]	28-1/2 [724]	49-1/8 [1248]	55-1/2 [1410]	49-5/8 [1260]	59-1/4 [1505]	7-5/8 [194]	44-1/2 [1130]	27-1/2 [699]	28-5/8 [727]	14-3/8 [365]	9-1/2 [241]
EXCLAIM 42	42 [1067]	28-1/2 [724]	49-1/8 [1248]	55-1/2 [1410]	49-5/8 [1260]	59-1/4 [1505]	7-5/8 [194]	50-1/2 [1283]	27-1/2 [699]	34-1/2 [876]	17-3/8 [441]	9-1/2 [241]
EXCLAIM 50	50 [1270]	33 [838]	54-3/8 [1381]	68-1/8 [1730]	60-1/4 [1530]	70-1/2 [1791]	8-3/4 [222]	60-5/8 [1540]	29-1/2 [749]	41-5/8 [1057]	20-3/4 [527]	11-5/8 [295]

**ROYAL HEARTH SPECIFICATIONS**

MODEL	FRONT WIDTH		BACK WIDTH		HEIGHT		DEPTH		FIREBOX OPENING
	UNIT	FRAMING	UNIT	FRAMING <sup>1</sup>	UNIT	FRAMING	UNIT	FRAMING	
RH-36	41 [1041]	42 [1067]	23-3/4 [603]	42 [1067]	39-1/2 [1003]	39-3/4 [1010]	21-3/8 [543]	21-1/2 [546]	36 x 21 [914 x 533]
RH-42	47 [1194]	48 [1219]	29-3/4 [756]	48 [1219]	39-1/2 [1003]	39-3/4 [1010]	21-3/8 [543]	21-1/2 [546]	42 x 21 [1067 x 533]

Drawings below represent the RH-36 and RH-42 combined.

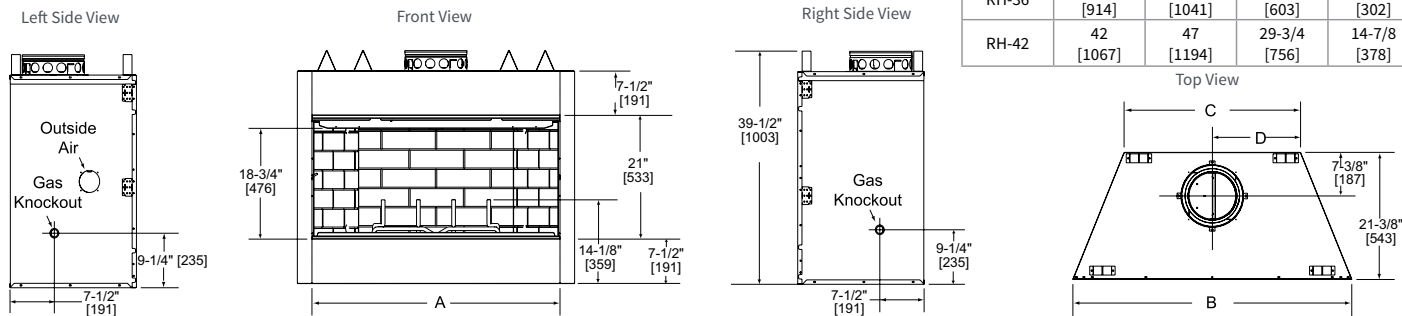

MODEL	A	B	C	D
RH-36	36 [914]	41 [1041]	23-3/4 [603]	11-7/8 [302]
RH-42	42 [1067]	47 [1194]	29-3/4 [756]	14-7/8 [378]



For complete information on this model, please  
contact us at:

**HEAT & GLO**

No one builds a better fire

Web: [heatnglo.com](http://heatnglo.com)

Phone: (888) 427-3973

E-mail: [info@heatnglo.com](mailto:info@heatnglo.com)

 [facebook.com/HeatandGlo](https://facebook.com/HeatandGlo)

 [twitter.com/HeatandGlo](https://twitter.com/HeatandGlo)

 [youtube.com/HeatandGlo](https://youtube.com/HeatandGlo)

---

**LIMITED LIFETIME WARRANTY<sup>2</sup>**

The strongest in the industry, Heat & Glo provides a limited lifetime warranty on the most important aspects: firebox and heat exchanger.

---

<sup>2</sup> For full warranty details, go to [www.heatnglo.com](http://www.heatnglo.com).

Fireplace, stove and insert surfaces get extremely HOT and can cause severe burns if touched. Keep a safe distance away. To learn more visit [heatnglo.com/fireplacesafety](http://heatnglo.com/fireplacesafety).



HNG-1029U-0223