



SimpliFire[®]
Fire Made Simple

Electric

Linear Electric Fireplaces

Show-stopping designs in a clean finish

BEST

SCION TRINITY

- Visually striking multisided design
- Install as three-sided (bay), two-sided (left- or right-corner), or single-sided
- Cleanest finish with concealed heat vents
- Tall, 15-inch high viewing for impactful room presence
- Extra-deep ember bed for an impressive media display
- Clear crystal media and driftwood logs with glowing embers come standard

Optional Accessories

- Floating mantel kit (for wall mount applications)
- ShadowGlo™ high-definition log sets



BEST

SCION

- Cleanest finish with concealed heat vents
- Tall, 15-inch high viewing for impactful room presence
- Extra-deep ember bed for an impressive media display
- Clear crystal media and driftwood logs with glowing embers come standard

Optional Accessories

- ShadowGlo™ high-definition log sets



BEST

Forum Outdoor

- Durable to withstand the elements
- Clean look with finishing materials to the edge or framed with included overlap front
- Clear crystal media and driftwood logs with glowing embers come standard

Optional Accessories

- ShadowGlo™ high-definition log sets



BETTER

ALLUSION PLATINUM

- Tall, 15-inch high viewing area with minimal frame
- Installs flush into a 2x6 wall, maximizing floor space
- Clear crystal and ceramic white stone media come standard

Optional Accessories

- Driftwood log set to enhance the allure
- Wall-mount kit available for quick and easy installation in any room



GOOD

ALLUSION

- Flexibility to recess fully, recess partially, or hang on the wall

Optional Accessories

- Driftwood log set to enhance the allure



GOOD

FORMAT

- Clean, built-in look in an easy-to-install wall mount design
- Clear crystal media and one-piece ShadowGlo Alpine Timber log set come standard



Scion Trinity

Create an alluring atmosphere from any angle with the SimpliFire Scion Trinity electric fireplace. In three-sided, corner, or single-sided configurations, it adds stunning ambiance without the need for gas lines or venting.

Features

- Bring finishing materials right to the edge of the fireplace for a flush, built-in look
- No mesh screen or visible heat vents
- Accent lighting for greater warmth and ambiance
- Clear crystal media and driftwood logs with glowing embers come standard
- Available in 43" and 55" models



Scion Trinity 55" with Driftwood logs

Included media



Clear crystals



Driftwood logs

Optional ShadowGlo log sets



Alpine Timber logs



Natural Birch logs



Scion Trinity 55" with floating mantel kit



Scion Trinity 43" with Driftwood logs



Scion 78" shown with orange flame and Clear Crystals

Scion

Distinctly express your style. Seamlessly finish your wall and bring materials right to the edge of the fireplace for sleek look. Concealed vents, dynamic flame and vibrant lights bring your room to life, clean and simple.

Features

- Bring finishing materials right up to the edge of the fireplace for a flush, built-in look
- No mesh screen or visible heat vents
- Accent lighting for greater warmth and ambiance
- Clear crystal media and driftwood logs with glowing embers come standard
- Available in 43", 55", and 78" wide models



Scion 55" linear shown with orange flame and Driftwood logs

Scion Linear Series

Included media



Clear crystals



Driftwood logs

Optional ShadowGlo log sets



Alpine Timber logs



Natural Birch logs



Scion 78" shown with blue flame and Clear Crystals

Allusion Platinum

Creating an elegant focal point in your home has never been easier. Designed with comfort and ambiance in mind, the Allusion Platinum provides an impressive viewing area within a minimal frame.

Features

- Clear crystal media and ceramic white stones come standard
- Available in 50", 60", and 72" wide models
- Flexible installation: Fully recess for a flush look, or surface-mount with the optional wall-mount kit
- Optional non-structural Boyd Build-Out kit; 50" model only



Wall Mounted



Fully Recessed



Allusion Platinum 60" linear shown with blue flame and ceramic white stones

Included media



Clear crystals



Ceramic white stones

Optional media



Driftwood Logs

Optional Boyd Build-Out Kit



For our 50-inch model, choose to finish with the optional Boyd build-out kit. It's a simple addition for big impact, giving you a built-in look without any need for construction. Choose modern Farmhouse white shiplap or a ready-to-finish design.



Allusion Platinum 50" shown with Optional Boyd Build-Out Kit - Modern Farmhouse Style

Allusion

The Allusion electric fireplace series embraces modern design by combining linear proportions with a multitude of flame and LED ember bed lighting themes.

Features

- Clear crystal media creates the illusion of a soothing fire rising from a lighted ember bed
- Available in 40", 48", 60" or 84" wide models
- Simple touch controls on the fireplace front for added convenience
- Flexible installation: fully or partially recess or hang on the wall



Fully Recessed



Partially Recessed



Wall Mounted

Optional media



Driftwood Logs



Ceramic Stones



Allusion 48" linear shown with blue orange flame, white ember bed lighting and clear crystal media

Allusion Linear Series



Allusion 48" shown with orange flame and Driftwood logs

Format

We all desire simplicity in everyday life. The SimpliFire Format wall-mounted electric fireplace is the easiest way to add a modern centerpiece to any space. The minimalist floating-mantel design, available in several lengths, fits your décor with multi-colored accent lighting to set the mood.

Features

- Minimalist floating mantel provides a clean, built-in look in an easy wall-mount design
- Available in 43", 50" and 60" sizes
- No mesh screen or visible heat vents
- Clear crystal media and ShadowGlo™ Alpine Timber log set come standard
- Enjoy year-round with or without heat
- Easy control with the intuitive, multifunction remote



Format 60" linear shown with ShadowGlo Alpine Timber log set

Included media



ShadowGlo Alpine Timber log set



Clear crystals



Format 43" shown with orange flame and Clear Crystals

Forum Outdoor

The SimpliFire Forum outdoor electric fireplace is the easiest way to turn your patio or deck into a go-to oasis. Designed for outdoors and with the flexibility to place it anywhere, the Forum expands your livable area with freedom from propane tanks, gas lines or wood.

Features

- Big presence in 43" and 55" linear sizes
- Durable to withstand the elements
- Clean look with finishing materials to the edge or framed with included overlap front
- Four flame and 13 ember-bed colors to fit your mood
- Pick the look you want, from clear crystals or driftwood logs with glowing embers
- No heat allows you to safely place a TV or artwork directly above your fireplace
- Easy remote control



Forum 55" outdoor linear built-in (frameless look without front) with Crystal media

Forum Linear Series - Outdoor

Included media



Clear crystals



Driftwood logs

Optional ShadowGlo log sets



Alpine Timber logs



Natural Birch logs



Forum 43" outdoor linear recessed (with self-trimming front) shown with Driftwood logs

Linear Electric Fireplace Features and Options

Model	Scion Trinity 43", 55"	Scion 43", 55", 78"	Allusion Platinum 50", 60", 72"	Allusion 40", 48", 60", 84"	Format 43", 50", 60"	Forum 43", 55"
Flame Colors	4	4	4	4	4	4
Ember Bed Colors	13	13	13	13	13	13
Accent Lighting	YES	YES	NO	NO	YES - Multi-Colored	YES
Remote	YES	YES	YES	YES	YES	YES
Thermostat Mode	YES	YES	YES	YES	YES	NO
Included Media	-Clear Crystals -Driftwood Logs	-Clear Crystals -Driftwood Logs	-Clear Crystals -Ceramic White Stones	-Clear Crystal Media	-Clear Crystals -ShadowGlo Alpine Timber log set (one-piece)	-Clear Crystals -Driftwood Logs
Optional Media	ShadowGlo™ Logs: -Alpine Timber -Natural Birch	ShadowGlo™ Logs: -Alpine Timber -Natural Birch	-Driftwood Logs	-Driftwood Logs -Ceramic White Stones	N/A	ShadowGlo™ Logs: -Alpine Timber -Natural Birch
Installation Method	-Built-In 3-Sided (Bay) -Built-In 2-Sided (Left/Right Corner) -Built-In Single-Sided -Wall Mount (with optional floating mantel kit)	-Built-In Flush	-Fully Recess 2x6 Framing -Wall Mount (with optional kit) -Optional Boyd Build-Out Kit	-Recessed Flush in 2x6 Framing -Semi-Recess in 2x4 Framing -Wall Mount (wall mount included)	-Wall Mount	-Built-in Flush -Recessed with a self-trimming front
Electrical Connection	-15 AMP, 120V/60 Hz -Hardwire or Plug-In	-15 AMP, 120V/60 Hz -Hardwire Only	-15 AMP, 120V/60 Hz -Hardwire or Plug-In	-15 AMP, 120V/60 Hz -Hardwire or Plug-In	-12.5 AMP, 120V/60 Hz -Hardwire or Plug-In	-15AMP, 120V/60 Hz -Hardwire or Plug-In
Heat Output	Up to 5,000 BTUs; 1,500W High/750W Low	Up to 5,000 BTUs; 1,500W High/750W Low	Up to 5,000 BTUs; 1,500W High/750W Low	Up to 5,000 BTUs; 1,500W High/750W Low	Up to 5,000 BTUs; 1,500W High/750W Low	N/A

Thirteen ember bed colors

Ember beds are lit with the glow from long-lasting LED lights and provides 13 individual color options as well as the option to continuously rotate through all the colors.

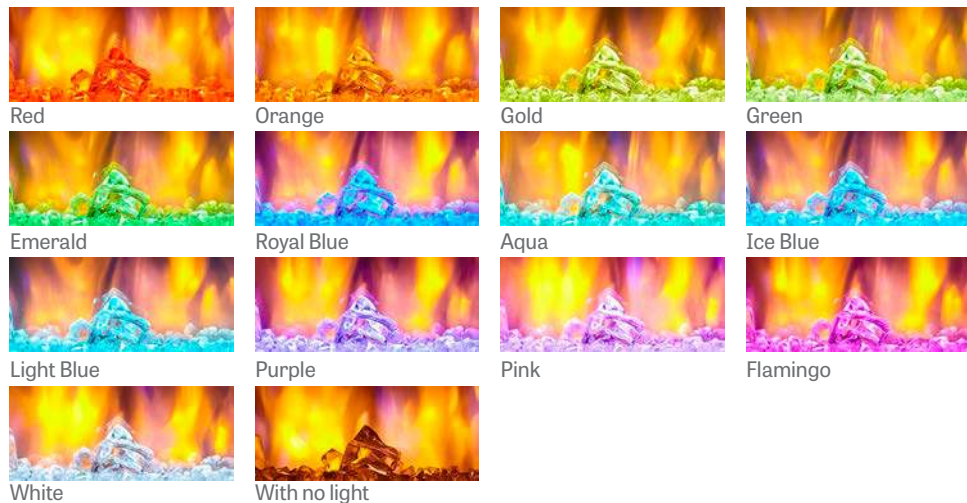

Four flame colors

LED flame technology delivers enhanced energy efficiency in four flame colors.

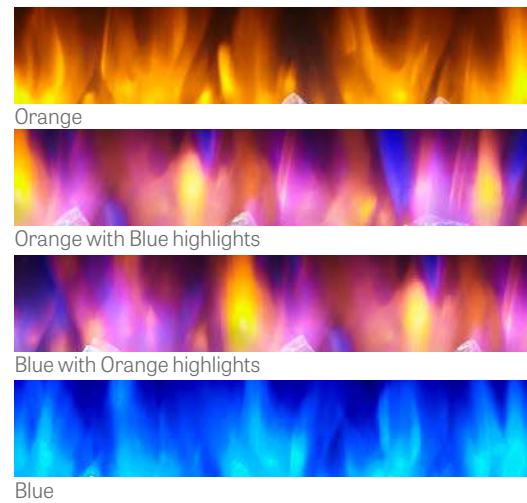

Multi-Function Remotes

An intuitive multifunction remote control comes standard.



- Scion Trinity
- Scion
- Allusion Platinum
- Allusion
- Forum

Scion Trinity



Model	BTU Output	Width (A)		Height (B)		Depth (C)		Viewing Area (D x E)
		Unit	Framing	Unit	Framing	Unit	Framing	
SF-SCT43-BK	5,000	42-1/2" [1080]	42-3/4" [1086]	22-1/4" [565]	22-5/8" [575]	11-1/4" [286]	11-1/2" [194]	42-1/2" x 14-3/4" [1080 x 375]
SF-SCT55-BK	5,000	54-1/2" [1384]	54-5/8" [1387]	22-1/4" [565]	22-5/8" [575]	11-1/4" [286]	11-1/2" [194]	54-1/16" x 14-3/4" [1373 x 375]

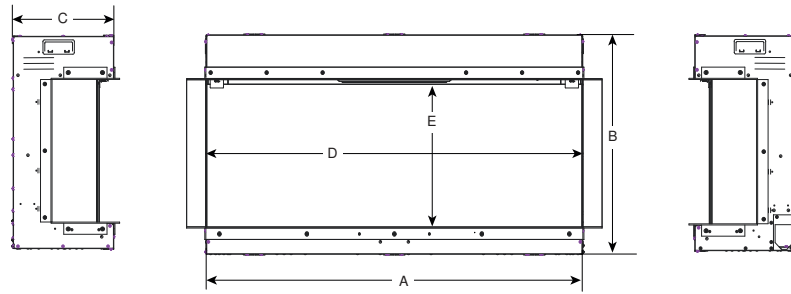

Side View

Front View

Side View

Scion



Model	BTU Output	Width (A)		Height (B)		Depth (C)		Viewing Area (D x E)
		Unit	Framing	Unit	Framing	Unit	Framing	
SF-SC43-BK	5,000	44-1/2" [1130]	45" [1143]	23-7/8" [606]	24-1/4" [616]	7-5/8" [194]	7-5/8" [194]	41-1/2" x 15" [1054 x 381]
SF-SC55-BK	5,000	56-1/2" [1435]	57" [1448]	23-7/8" [606]	24-1/4" [616]	7-5/8" [194]	7-5/8" [194]	53-1/4" x 15" [1353 x 381]
SF-SC78-BK	5,000	80" [2032]	80-1/2" [2045]	23-7/8" [606]	24-1/4" [616]	7-5/8" [194]	7-5/8" [194]	76-7/8" x 15" [1953 x 381]

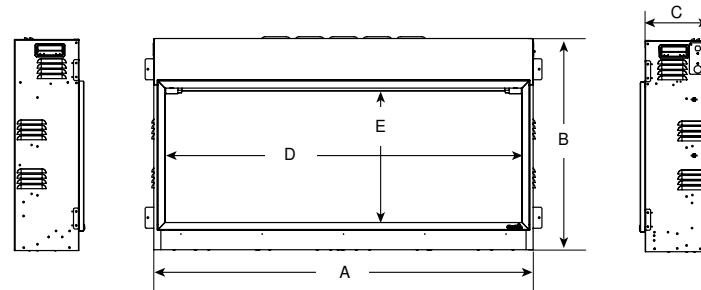

Side View

Front View

Side View

Allusion Platinum



Optional Boyd Build-Out Kit for 50" Allusion Platinum

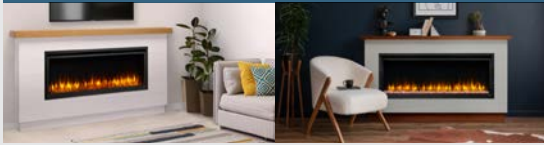

Model	BTU Output	Width			Height			Depth		Viewing Area (F x G)
		Front (A)	Back (B)	Framing	Front (C)	Back (D)	Framing	Unit (E)	Framing*	
SF-ALLP50-BK	5,000	52-5/16" [1329]	50-1/2" [1295]	51" [1 295]	20-7/16" [519]	19-3/8" [492]	19-3/4" [502]	5-5/8" [143]	2" x 6"	48" x 15" [1219 x 381]
SF-ALLP60-BK	5,000	62-5/16" [1583]	60-1/2" [1537]	61" [1549]	20-7/16" [519]	19-3/8" [492]	19-3/4" [502]	5-5/8" [143]	2" x 6"	58" x 15" [1473 x 381]
SF-ALLP72-BK	5,000	74-5/16" [1888]	72-1/2" [1842]	73" [1854]	20-7/16" [519]	19-3/8" [492]	19-3/4" [502]	5-5/8" [143]	2" x 6"	70" x 15" [1778 x 381]

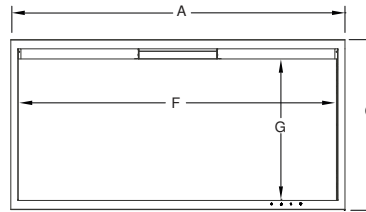

Front View

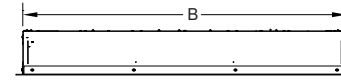

Top View

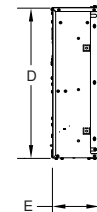

Side View

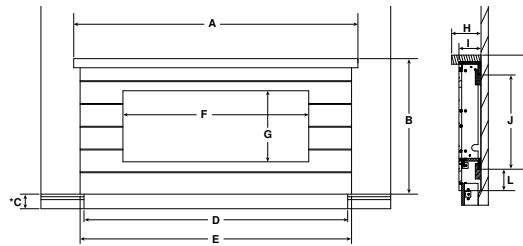

Front View

Side View

* Baseboard height if using toe kick.

Model	A	B	*C	D	E	F
Modern Farmhouse BOK-MF-ALLP50	in. 78-1/8	37-1/4	1-1/2 - 5-1/2	72-1/2	74-1/4	51
	mm 1984	946	38 - 140	1842	1886	1295
Ready-to-Finish BOK-RTF-ALLP50	in. 67-3/4	34-1/2	1-1/2 - 5-1/2	62-3/4	64-3/4	51
	mm 1721	876	38 - 140	1594	1645	1295

Model	G	H	I	J	K	L
Modern Farmhouse BOK-MF-ALLP50	in. 19-1/2	8	6-1/16	26-3/4	32-3/8	5-1/8
	mm 495	203	154	679	822	130
Ready-to-Finish BOK-RTF-ALLP50	in. 19-1/2	7-1/2	6-1/16	26-3/4	31-1/4	3-1/4
	mm 495	191	154	679	794	83

Allusion



Model	BTU Output	Width			Height			Depth		Viewing Area (F x G)
		Front (A)	Back (B)	Framing*	Front (C)	Back (D)	Framing*	Unit (E)	Framing*	
SF-ALL40-BK	5,000	40-1/2" [1029]	35" [889]	36" [914]	20-1/4" [515]	18" [457]	18-3/8" [467]	5-15/16" [151]	2" x 6"	31-3/8" x 11-1/4" [797 x 285]
SF-ALL48-BK	5,000	48-7/16" [1230]	42-13/16" [1088]	44-5/16" [1126]	20-1/4" [515]	18" [457]	18-3/8" [467]	5-15/16" [151]	2" x 6"	39-3/8" x 11-1/4" [1000 x 285]
SF-ALL60-BK	5,000	60-1/4" [1530]	54-5/8" [1388]	56-1/8" [1426]	20-1/4" [515]	18" [457]	18-3/8" [467]	5-15/16" [151]	2" x 6"	51-3/16" x 11-1/4" [1300 x 285]
SF-ALL84-BK	5,000	83-7/8" [2130]	78-1/4" [1988]	79-1/2" [2019]	20-1/4" [515]	18" [457]	18-3/8" [467]	5-15/16" [151]	2" x 6"	74-7/8" x 11-1/4" [1902 x 285]

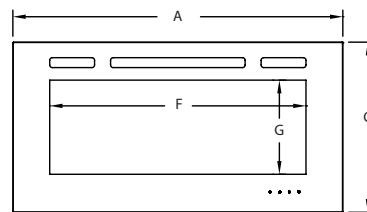

Front View

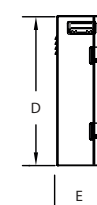

Side View

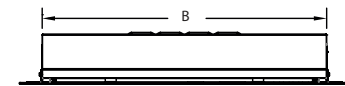

Top View

Format



Model	BTU Output	Width (A)	Height (B)	Depth (C)	Depth (D)	Sides (E)	Viewing Area (F x G)
SF-FM50-WH	5,000	50" [1270]	23-5/16" [592]	7-7/8" [200]	9-7/8" [250]	6-7/8" [175]	36-1/16" x 12-5/8" [916 x 321]
SF-FM60-WH	5,000	59-7/8" [1520]	23-5/16" [592]	7-7/8" [200]	9-7/8" [250]	11-13/16" [300]	36-1/16" x 12-5/8" [916 x 321]

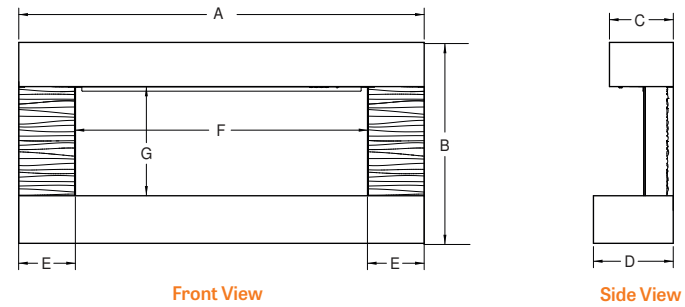

Model	BTU Output	Width (A)	Width (B)	Height (C)	Depth (D)	Depth (E)	Viewing Area (F x G)
SF-FM43-WH	5,000	37-13/16" [960]	43-5/16" [1100]	23-5/16" [592]	7-7/8" [200]	9-7/8" [250]	36-1/16" x 12-5/8" [916 x 321]

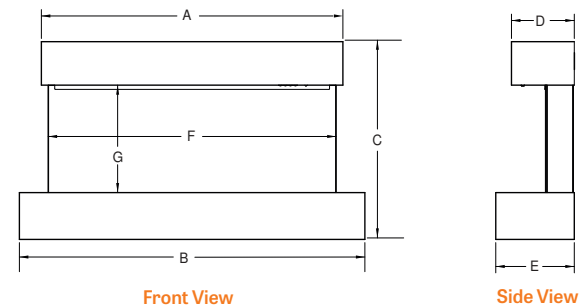

Outdoor Forum



Model	Width (A)	Height (B)	Depth (C)	Glass Size (D x E)
SF-OD43	46" [1168]	18-1/8" [460]	8-1/4" [210]	43-1/2" x 15-7/16" [1104 x 392]
SF-OD55	58" [1473]	18-1/8" [460]	8-1/4" [210]	55-1/2" x 15-7/16" [1410 x 392]

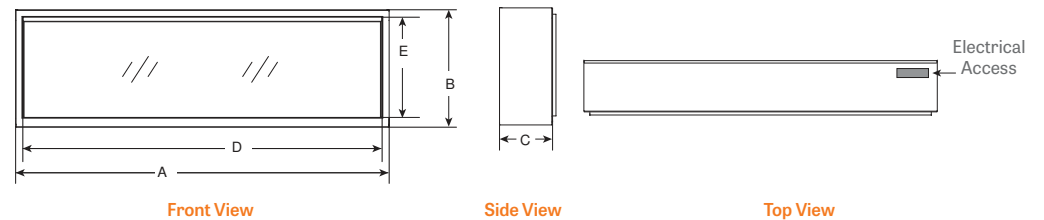



SimpliFire[®]
Fire Made Simple



[simplifire.com](https://www.simplifire.com)



SFE-1011U-1122