



**VERMONT**  **CASTINGS™**  
**BY FORGE & FLAME**

---

WOOD-BURNING STOVES

# TRUE CRAFTSMANSHIP

---

Vermont Castings was founded on the belief that the stately beauty of cast iron could be combined with the simple utility of wood heat, to craft stoves of value and enduring beauty.

Among the vibrant hills and silver waters of the Green Mountain State is one constant: the promise of American craftsmanship. This is where day after day, year after year, the proud people of Vermont Castings craft each product with hand and heart.

Vermont Castings provides more than heat. It's the warmth that unites. The timeless designs and furniture-quality finish set the scene for intimate memories. No detail is too small, no element insignificant. This is true craftsmanship.

---

**VERMONT**  **CASTINGS™**



# KEY TECHNOLOGIES

## FLEXBURN® TECHNOLOGY

FlexBurn stoves burn with or without a catalyst and achieve up to 15% higher efficiency on low burns with the catalyst in place.



### ① START UP

- Primary burn started and fueled by fresh air
- Bypass damper is open



### ② 2-STAGE BURN

- Damper is closed once stove and flue are sufficiently hot, forcing smoke into the secondary combustion chamber
- Additional air feeds combustion of gases for secondary burn

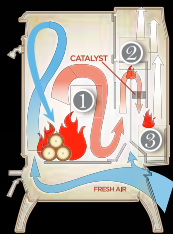

### ③ 3-STAGE BURN

- With catalyst in place, increased efficiency and lower emissions result from a tertiary burning of gases and CO
- The catalyst also enables combustion at much lower temperatures, extending burn times and saving on fuel costs

### SAVE MONEY AND USE LESS WOOD WITH A CATALYST

Increase your heating efficiency and lower your stove emissions, ensuring you get the most out of each load of wood.

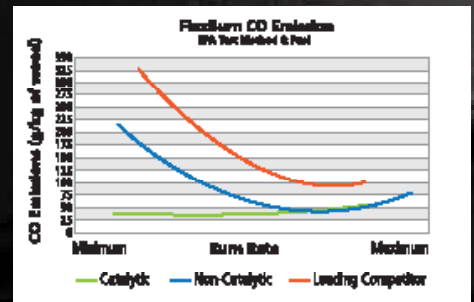
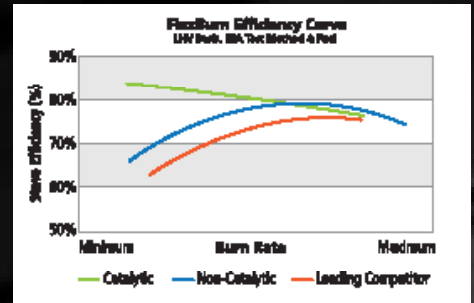

## TOP LOAD TECHNOLOGY

Our top load technology is second to none and perhaps the most celebrated feature of Vermont Castings stoves.

Top loading lends itself to numerous conveniences and safety features:

- The top load design increases load capacity by allowing you to utilize the entire fire box; load the firebox right to the top for longer burns
- Top loading is safer and cleaner, keeping ash and embers contained
- The smokeless design releases less smoke in your room than loading from the front
- Direct heat to the stovetop results in a superior cooking surface



## THERMOSTATICALLY CONTROLLED COMBUSTION

Our unique, built-in thermostat requires no electricity and automatically adjusts the required air for combustion. Just set the stove for the heat output you want and let the thermostat do the rest. The result—longer, more even heat.

## CONTINUOUS COMBUSTION CONTROL™ (C3)

Our exclusive C3 technology is tuned to provide optimal burn throughout the life of your fire. From startup to last coals, C3 technology manages all the give-and-take for you, automatically adjusting and delivering just the right amount of air to optimize efficiency and heat output. This heat activated technology requires no electricity or manual air controls. The result – the most consistent, easiest burn you will experience.



Shown with Traditional Doors

# DEFIANT WOOD STOVE



Thermostatically  
Controlled Combustion



Top Load  
Technology

## KEY FEATURES



Timeless cast iron styling with a furniture-quality finish



Convenient top load keeps smoke and ash contained and increases load capacity



Exclusive swing-out ash pan allows you to cleanly remove ashes, even when the stove is hot



Cast iron griddle top offers a versatile cooking surface for the stovetop chef



Shown with Transitional Doors

# ENCORE WOOD STOVE



Thermostatically  
Controlled Combustion



Top Load  
Technology

## KEY FEATURES



Timeless cast iron styling with a furniture-quality finish



Convenient top load keeps smoke and ash contained and increases load capacity



Exclusive swing-out ash pan allows you to cleanly remove ashes, even when the stove is hot



Cast iron griddle top offers a versatile cooking surface for the stovetop chef



# DAUNTLESS FLEXBURN WOOD STOVE



FlexBurn Technology



Thermostatically Controlled Combustion



Top Load Technology

## KEY FEATURES



Timeless cast iron styling with a furniture-quality finish



Convenient top load keeps smoke and ash contained and increases load capacity



Exclusive swing-out ash pan allows you to cleanly remove ashes, even when the stove is hot



Cast iron griddle top offers a versatile cooking surface for the stovetop chef



Shown with Traditional Doors

# INTREPID FLEXBURN WOOD STOVE



FlexBurn Technology



Thermostatically Controlled Combustion



Top Load Technology

## KEY FEATURES



Timeless cast iron styling with a furniture-quality finish



Convenient top load keeps smoke and ash contained and increases load capacity



Exclusive swing-out ash pan allows you to cleanly remove ashes, even when the stove is hot



Cast iron griddle top offers a versatile cooking surface for the stovetop chef



# ASPEN<sup>®</sup>C3 WOOD STOVE



Continuous Combustion  
Control (C3) Technology

## KEY FEATURES



Timeless cast iron styling with a furniture-quality finish



North-south orientation for easy loading



Top plate cooking surface for the stove top chef



Up to 10 hours of burn time from each load of wood



# GALLERY



**ENCORE** Shown with Traditional Doors



**INTREPID FLEXBURN** Shown with Traditional Doors



**DAUNTLESS FLEXBURN**



**ASPEN C3**



**DEFIANT** Shown with Traditional Doors



**DAUNTLESS FLEXBURN**

# OPTIONS & ACCESSORIES



CAST IRON STEAMER



CAST IRON TRIVET



MAGNETIC STOVE TOP THERMOMETER



VERMONT CASTINGS LEATHER GLOVES



CAST IRON WOOD BIN



PORTABLE SAFETY SCREEN



OUTSIDE AIR ADAPTER



MATCHING ENAMEL PIPE



CATALYTIC PERFORMANCE PACK



TRANSITION STYLE DOORS



WARMING SHELVES



VARIABLE SPEED FAN KIT

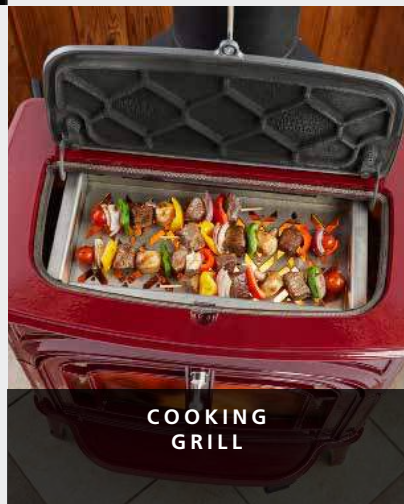

COOKING GRILL



DECORATIVE VINTAGE COOK PLATE

OPTION	DEFIANT	ENCORE	DAUNTLESS FLEXBURN	INTREPID FLEXBURN	ASPEN C3
Cast Iron Steamer	•	•	•	•	•
Cast Iron Trivet	•	•	•	•	•
Stove Top Thermometer	•	•	•	•	•
Leather Gloves	•	•	•	•	•
Cast Iron Wood Bin	•	•	•	•	•
Portable Safety Screen	•	•	•	•	•
Outside Air Adapter	•	•	Included	Included	•
Enamel Finish Pipe <sup>1</sup>	•	•	•	•	
Catalytic Performance Pack	Included	Included	•	•	
Transition Doors	•	•		•	
Warming Shelves	•	•		•	
Variable Speed Fan Kit	•	•	•		
Cooking Grill			•		
Decorative Vintage Cook Plate					•

## STOVE FINISHES



### CLASSIC BLACK

AVAILABLE ON:

Defiant

Encore

Dauntless FlexBurn

Intrepid FlexBurn

Aspen C3



### BORDEAUX ENAMEL

AVAILABLE ON:

Defiant

Encore

Dauntless FlexBurn

Intrepid FlexBurn



### MAJOLICA BROWN ENAMEL

AVAILABLE ON:

Defiant

Encore

Dauntless FlexBurn

Intrepid FlexBurn



### TWILIGHT ENAMEL

AVAILABLE ON:

Defiant

Encore

Dauntless FlexBurn

Intrepid FlexBurn

1: Enamel finish pipe not available in Twilight Enamel.

# SPECIFICATIONS

## DEFIANT

Peak BTU/hr Output <sup>1</sup>	56,000
Heating Capacity <sup>2</sup>	1,300 - 2,800 sq ft
Maximum Burn Time <sup>3</sup>	14 hrs
Efficiency <sup>4</sup>	84% LHV; 78% HHV
Emissions	1.3 g/hr
Firebox Capacity	3.2 cu ft
Recommended Log Length	20"
Actual Weight	518 lbs
Technologies	Thermostatically Controlled Combustion, Top Load Technology

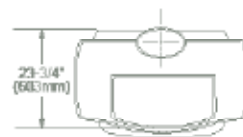

Top

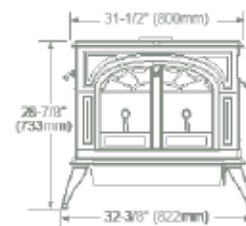

Front

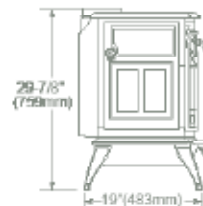

Side - Top Vent

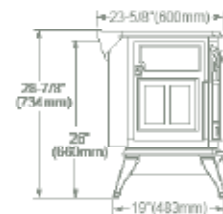

Side - Rear Vent

## ENCORE

Peak BTU/hr Output <sup>1</sup>	48,000
Heating Capacity <sup>2</sup>	900 - 2,300 sq ft
Maximum Burn Time <sup>3</sup>	12 hrs
Efficiency <sup>4</sup>	83% LHV; 77% HHV
Emissions	1.1 g/hr
Firebox Capacity	2.3 cu ft
Recommended Log Length	18"
Actual Weight	475 lbs
Technologies	Thermostatically Controlled Combustion, Top Load Technology

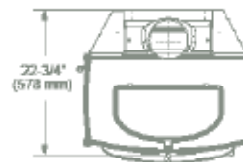

Top

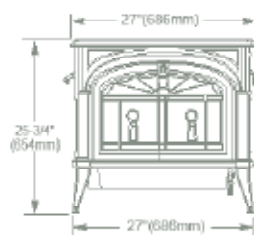

Front

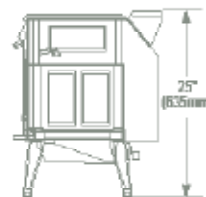

Side - Top Vent

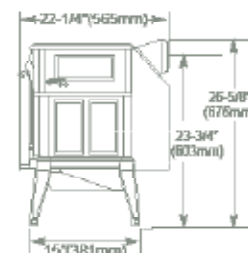

Side - Rear Vent

## DAUNTLESS FLEXBURN

Peak BTU/hr Output <sup>1</sup>	45,500
Heating Capacity <sup>2</sup>	800-2,000 sq ft
Maximum Burn Time <sup>3</sup>	11 hrs
Efficiency <sup>4</sup>	LHV: 83% (Catalytic) 82% (Non-Catalytic) HHV: 78% (Catalytic) 77% (Non-Catalytic)
Emissions	1.2 g/hr (Catalytic) 1.1 g/hr (Non-Catalytic)
Firebox Capacity	1.8 cu ft
Recommended Log Length	16"
Actual Weight	390 lbs
Technologies	FlexBurn, Thermostatically Controlled Combustion, Top Load Technology

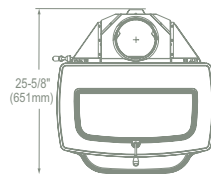

Top

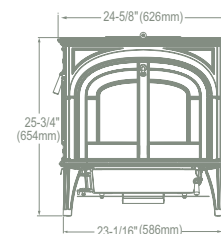

Front

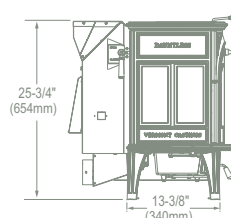

Side - Top Vent

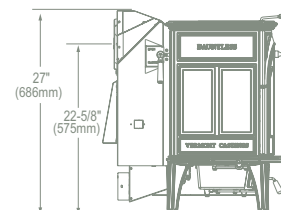

Side - Rear Vent

## INTREPID FLEXBURN

Peak BTU/hr Output <sup>1</sup>	37,000
Heating Capacity <sup>2</sup>	600 - 1,800 sq ft
Maximum Burn Time <sup>3</sup>	8 hrs
Efficiency <sup>4</sup>	LHV: 83% (Catalytic) 80% (Non-Catalytic) HHV: 77% (Catalytic) 74% (Non-Catalytic)
Emissions	0.3 g/hr (Catalytic) 0.6 g/hr (Non-Catalytic)
Firebox Capacity	1.3 cu ft
Recommended Log Length	14"
Actual Weight	348 lbs
Technologies	FlexBurn, Thermostatically Controlled Combustion, Top Load Technology

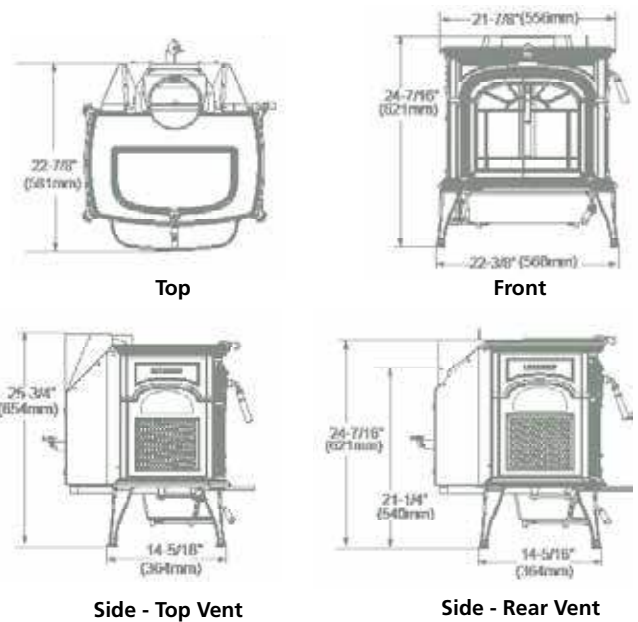

## ASPEN C3 SPECIFICATIONS

Peak BTU/hr Output <sup>1</sup>	35,200
Heating Capacity <sup>2</sup>	400 - 1,200 sq ft
Maximum Burn Time <sup>3</sup>	10 hrs
Efficiency <sup>4</sup>	81% LHV; 75% HHV
Emissions	1.99 g/hr
Firebox Capacity	1.25 cu ft
Recommended Log Length	16"
Actual Weight	215 lbs
Technologies	Continuous Combustion Control (C3)

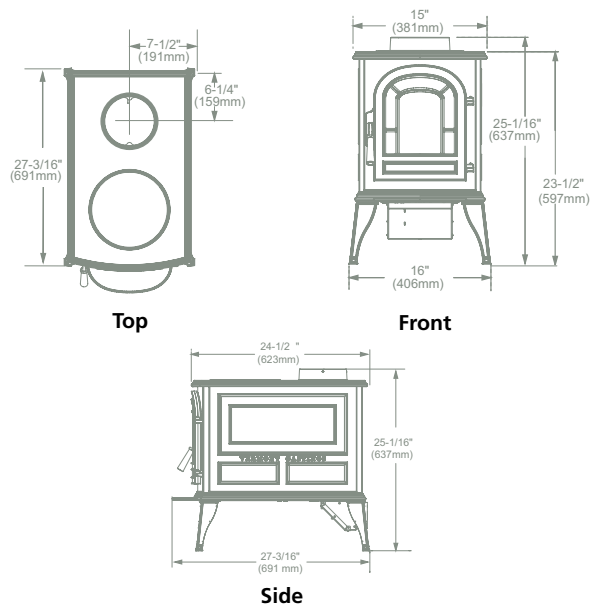

1. BTU: 1st hour output uses high burn efficiency number. BTU will vary depending on the type of fuel used and moisture content of the fuel. 2. This is a general guide, see your local dealer for help in determining the product that best suits your heating needs based on climate, home efficiency, location of the heater, and air movement in the room. 3. Actual burn times will vary

based on how the appliance is operated, load size, moisture content and type of wood used. 4. Weighted Average LHV (Low Heating Value) efficiency. HHV (High Heat Value) efficiency used to qualify products for Tax Credit beginning in 2021.

# CLEARANCES

## DEFIANT

6" or 8" single or double wall pipe	CLEARANCES TO COMBUSTIBLES			
	PARALLEL INSTALLATION			CORNER INSTALLATION
	Side (A)	Rear		Corner (D)
To rear shroud (B)		To back edge of cast (C)		
Top exit, single wall connector pipe	21" (521 mm)	15" (381 mm)	21" (521 mm)	5" (127 mm)
Top exit, double wall connector pipe	21" (521 mm)	15" (381 mm)	21" (521 mm)	5" (127 mm)
Rear exit	21" (521 mm)	10" (254 mm)	16" (407 mm)	N/A

### UNPROTECTED SURFACE



Stove parallel to wall

Stove in corner

Standard floor protection: 44" x 46" minimum. See manual for corner floor protection sizes and diagrams, for single and double wall pipe.

Refer to manual for complete list of clearances prior to installation.

Oval to round adaptor required for installation.

## ENCORE

6" single or double wall pipe	CLEARANCES TO COMBUSTIBLES		
	PARALLEL INSTALLATION	CORNER INSTALLATION	
	Side (A)	Rear (B)	Corner (C)
Top exit, 6" single wall connector w/o shields	19-1/2" (495 mm)	20" (508 mm)	15" (381 mm)
Rear exit	19-1/2" (495 mm)	14" (356 mm)	N/A
Top exit, double wall connector pipe	18-1/2" (469 mm)	11" (280 mm)	7-1/2" (191 mm)
Top exit, 6" single wall connector w/o shields	19-1/2" (495 mm)	15" (381 mm)	15" (381 mm)

### UNPROTECTED SURFACE



Stove parallel to wall

Stove in corner

Standard floor protection: 39-1/4" x 44" minimum. See manual for corner floor protection sizes and diagrams, for single and double wall pipe.

Refer to manual for complete list of clearances prior to installation.

## DAUNTLESS FLEXBURN

6" single or double wall pipe	CLEARANCES TO COMBUSTIBLES		
	PARALLEL INSTALLATION	CORNER INSTALLATION	
	Side (A)	Rear (B)	Corner (C)
Top exit, single wall pipe	14" (356 mm)	14" (356 mm)	15" (381 mm)
Rear exit	14" (356 mm)	10" (254 mm)	N/A
Top exit, double wall pipe	12" (305 mm)	12" (305 mm)	7" (178 mm)

### UNPROTECTED SURFACE

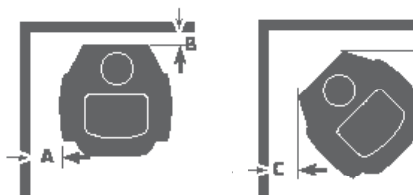

Stove parallel to wall

Stove in corner

Standard floor protection: 35-3/8" x 39-3/8" minimum. See manual for corner floor protection sizes and diagrams, for single and double wall pipe.

Refer to manual for complete list of clearances prior to installation.

## INTREPID FLEXBURN

6" single or double wall pipe	CLEARANCES TO COMBUSTIBLES		
	PARALLEL INSTALLATION		CORNER INSTALLATION
	Side (A)	Rear (B)	Corner (C)
Top exit, single wall pipe	15" (381 mm)	12" (305 mm)	6-1/2" (165 mm)
Rear exit	15" (381 mm)	13" (330 mm)	N/A
Top exit, double wall pipe	11" (280 mm)	10" (254 mm)	6" (152 mm)

### UNPROTECTED SURFACE

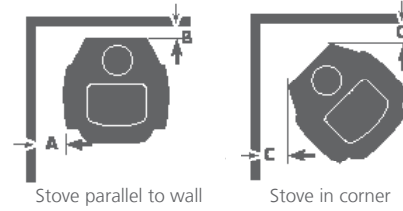

Standard floor protection: 34" x 40" minimum. See manual for corner floor protection sizes and diagrams, for single and double wall pipe.  
Refer to manual for complete list of clearances prior to installation.

## ASPEN C3 CLEARANCES

6" single or double wall pipe	CLEARANCES TO COMBUSTIBLES		
	PARALLEL INSTALLATION		CORNER INSTALLATION
	Side (A)	Rear (B)	Corner (C)
Single Wall Pipe	14" (356 mm)	8" (203 mm)	6" (152 mm)
Double Wall Pipe	14" (356 mm)	3" (76 mm)	3" (76 mm)

### UNPROTECTED SURFACE

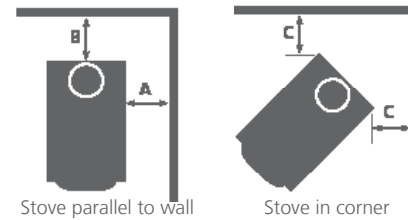

Standard floor protection: 25-1/2" x 39-7/16" minimum. See manual for corner floor protection sizes and diagrams, for single and double wall pipe.  
Refer to manual for complete list of clearances prior to installation.



---

#### LIMITED LIFETIME WARRANTY

The strongest in the industry, Vermont Castings provides a limited lifetime warranty on the most important aspects: firebox and heat exchanger. For full warranty details go to [VermontCastings.com](http://VermontCastings.com).

[vermontcastings.com](http://vermontcastings.com)

---

IMPORTANT - READ BEFORE YOU INSTALL! - Refer to the Owner/Installation Manual for complete clearance requirements and specifications. The images and descriptions in this brochure are provided to assist you in product selection only. Vermont Castings is a registered trademark of Hearth & Home Technologies. Product specifications and pricing subject to change without notice. Fireplace, stove and insert surfaces get extremely HOT and can cause burns if touched. Keep a safe distance away. To learn more visit [www.vermontcastings.com/fireplacesafety](http://www.vermontcastings.com/fireplacesafety). ©2020 Hearth & Home Technologies®, All rights reserved.